

TECHNICAL PARAMETER (技术参数)



- ▶ Description (描述)
100x100x200mm Nal(Tl) detector

- ▶ Scintillation crystal (闪烁晶体)
100x100x200mm Nal(Tl)

- ▶ PMT (光电倍增管)
Ø76mm, CR160

- ▶ Typical high voltage (高压范围)
400V-1100V

- ▶ Temperature range (温度范围)
-20 °C to +65 °C

- ▶ Energy resolution (能量分辨率)
≤8.5%@Cs137

DRAWING (尺寸图)

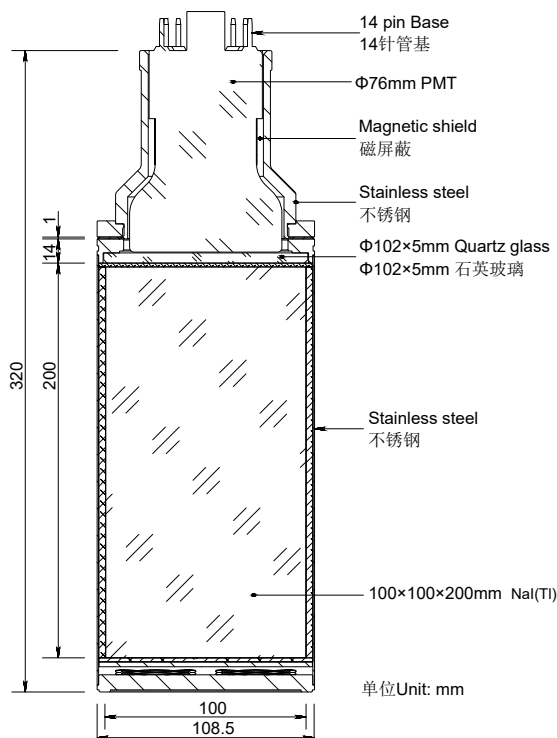

CONNECTORS (接口)

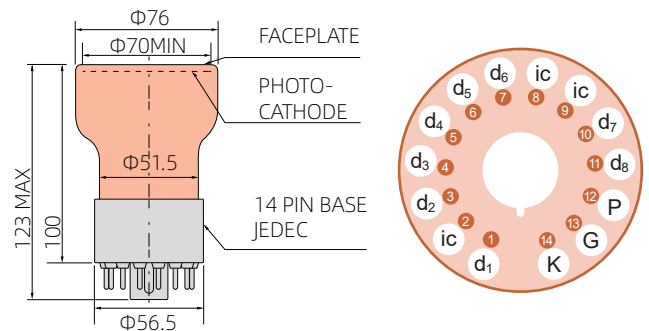

14-pins JEDEC connector (standard pin layout)

Pin 1 = Dynode 1	Pin 8 = n.c
Pin 2 = n.c	Pin 9 = n.c
Pin 3 = Dynode 2	Pin 10 = Dynode 7
Pin 4 = Dynode 3	Pin 11 = Dynode 8
Pin 5 = Dynode 4	Pin 12 = Anode
Pin 6 = Dynode 5	Pin 13 = Grid
Pin 7 = Dynode 6	Pin 14 = Cathode